

THIS DRAWING UNPUBLISHED.

RELEASED FOR PUBLICATION

LOC		DIST		REVISIONS			DATE	DWN	APVD
P	LTR								
-	-	-	-	-	-	-	-	-	

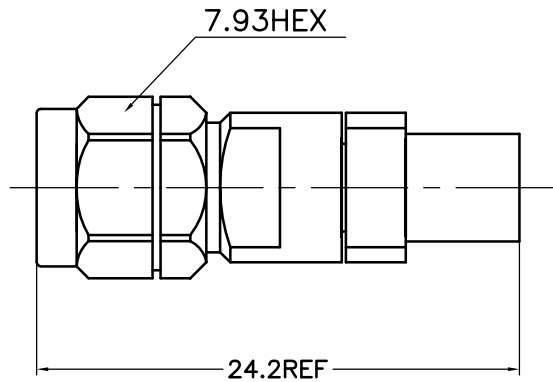

NOTES:

1.ELECTRICAL:

- 1.1 IMPEDANCE: 50Ω
- 1.2 INSULATION RESISTANCE:5000MΩ MIN
- 1.3 FREQUENCY RANGE: DC~40GHz
- 1.4 DIELECTRIC WITHSTANDING VOLTAGE: 1000V MAX AT SEA LEVEL
- 1.5 VSWR≤1.25:1@40GHz
- 1.6 INSERTION LOSS: 0.05√FREQUENCY

2.ENVIRONMENTAL:

TEMPERATURE RANGE: -55° to +165°

3.MATERIAL AND FINISH:

BODY: STAINLESS STEEL TYPE 303, PASSIVATE
 NUT: STAINLESS STEEL TYPE 303, PASSIVATE
 CENTER CONTACT: BERYLLIUM COPPER,
 GOLD PLATING
 DIELECTRIC: PEEK, N/A

THIS DRAWING IS A CONTROLLED DOCUMENT.		DWN DWP	25/07/2009	Micable Inc.		
		CHK				
DIMENSIONS MM	TOLERANCES UNLESS OTHERWISE SPECIFIED:	APVD	NAME			
	0 PLC ±0.25 1 PLC ±0.15 2 PLC ±0.12 3 PLC ± 4 PLC ± ANGLES ±1°	PRODUCT SPEC	2.4 mm PLUG TO SS405 CABLE			
MATERIAL	FINISH	APPLICATION SPEC	SIZE	CAGE CODE	DRAWING NO	
SEE TABLE	SEE TABLE	WEIGHT	A3	00779	20100007	
CUSTOMER DRAWING			SCALE	SHEET	OF	
			4: 1	1	1	
			RVE	1		